



TECHNICAL SPECIFICATION	DZ-42-V
Lumens, Luminous efficacy	5713 lm, 141 lm/W
Joining console size	Ø40±62 mm
Standard rated voltage Maximum current	~ 230V 50Hz 0.18 A
Power factor @ 230V, 50Hz and full load	1
Ingress protection / Mechanical impacts protection level	IP67  / IK10
Electrical Protection	Class II 
Working temperature	-20°C ÷ 50°C
Construction of the body	Extruded and anodized aluminum
Seal of the optical part	EPDM
Optical lens material	Polycarbonate
Rated power	40.5 W
Weight	1.49 kg
	<b>Connection:</b> L – Line (brown) N – Neutral (blue)

### DIMENSIONS AND MOUNTING





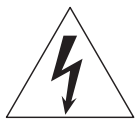
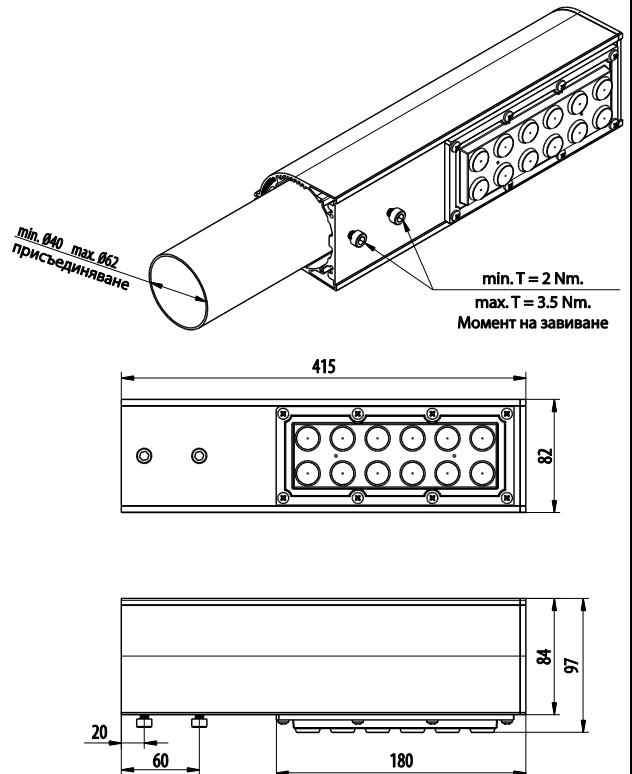



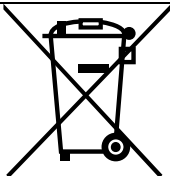







The luminaire should be mounted on a console with a minimum length of 80 mm and a slope of 15 to 30 ° (according to the light technical project). Maximum projected area of the wind power 350 cm<sup>2</sup>. When connecting to a pipe Ø 40 mm diameter, a bolt is required DIN 914-M6x30 and for Ø 60mm is required bolt DIN 914-M6x10



#### WARNING!

- These instructions must be followed for optimum and safe operation.
- Refer to a qualified specialist for installing and powering the luminaire.
- The luminaire is suitable for mounting on normally flammable surfaces at a distance of at least 1 meter from the illuminated surface.
- Prior to service or repair work, the power supply of the luminaire must be switched off.
- Any defect or burning of components, breakage of the safety glass (lens) or at the end of life of the luminaire must be completely replaced. If the external flexible cable is damaged, it must be replaced by the manufacturer.
- The light source of this luminaire is non-replaceable. When the light source reaches the end of its life, the entire luminaire must be replaced.
- The luminaire must be installed so that all exposed metal parts are not in contact with the electrical components.
- Always observe the polarity when connecting the power supply, and it is absolutely forbidden to install and extend the connection cable without the use of a special coupling socket.
- The manufacturer is not responsible for any damage resulting from non-compliance with the safety instructions.



IP	X	X	Protection
			IP23
			IP41
			IP43
			IP44
			IP54
			IP55
			IP65
			IP66
			IP67
			IP68